

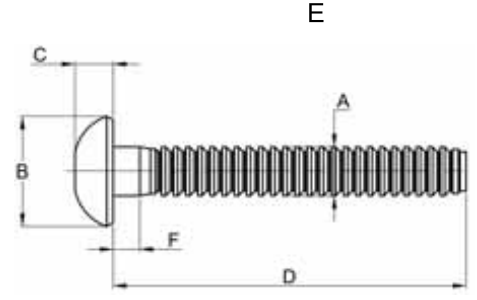

MAGNA-GRIP ÇELİK BOMBE KAFA

MAGNA-GRIP STEEL DOME HEAD

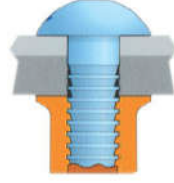

ÜRÜN NO PART NO	 mm	 [mm]	A	B	C	D	F
MGPB-R6-10	1,57 - 15,88	5,16	4,65 - 4,75	9,04 - 10,01	2,87 - 3,18	45,4	2,62 - 3,18
MGPB-R6-20	7,92 - 31,75	6,73	6,22 - 6,32	12,07 - 13,34	3,45 - 3,86	60,2	7,72 - 8,13
MGPB-R8-10	1,57 - 15,88	7,80 - 7,90	15,09 - 16,66	4,60 - 5,11	4,60 - 5,11	59,4	6,38 max
MGPB-R8-20	7,92 - 31,75	9,37 - 9,53	18,11 - 19,99	5,66 - 6,30	5,66 - 6,30	72,1	14,20 - 15,01
MGPB-R10-12	3,18 - 19,05	20,62 - 41,28				73,0	4,37 - 5,18
MGPB-R10-22	15,88 - 34,93					88,9	20,17 - 20,98
MGPB-R12-14	3,18 - 22,23						
MGPB-R12-26	20,62 - 41,28						

KOD	Ø	F	K	H	J
MGC-R6U	4,8	7,9	9,1	7,0	1,2
MGC-R8U	6,4	10,3	12,7	9,5	1,7
MGC-R10U	7,9	12,8	15,9	11,1	2,1

HAVŞA KAFA / COUNTERSUN HEAD

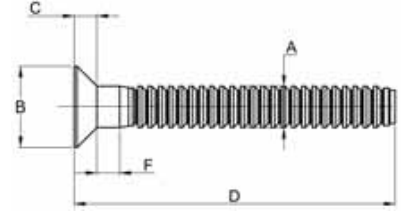

Kesme Kopma Değerleri (N) Shear Tensile Values (N)

ÇAP Ø	SIKMA	KESME	KOPMA
4,8	7670	6230	4110
	7670	6230	4110
6,4	9790	11340	5340
	9790	11340	5310
7,9	13340	17390	9560
	13340	17390	9560
9,5	18680	25020	14320
	18680	25050	14320

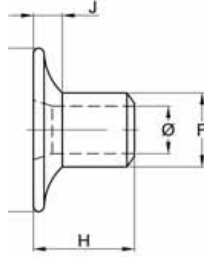

EXT GENİŞ KAFA / EXT LARGE HEAD

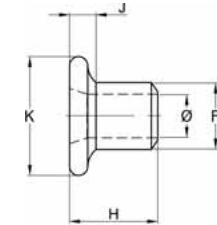
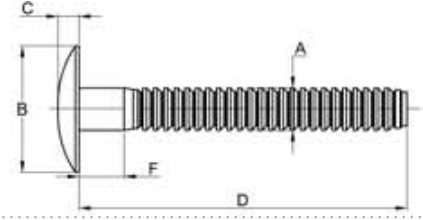

BOMBE KAFA / DOME HEAD

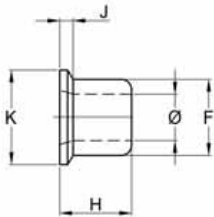
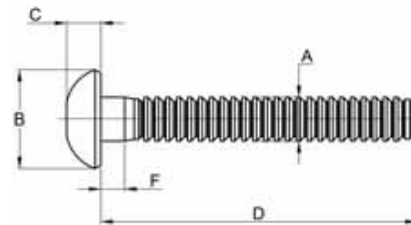

GENİŞ KAFA / LARGE HEAD

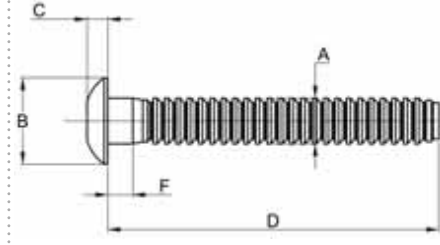

DAR KAFA / RİVET HEAD

